



ECO D-110 Security handle sets

Product information



■ SYSTEM TECHNOLOGY FOR THE DOOR

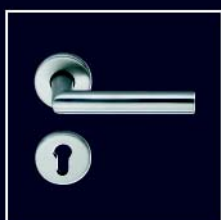

Product characteristics

Tested acc. to	EN 1906
With 9 mm spindle acc. to DIN 18273 fire protection tested	F
Lever form for escape doors and emergency exits	EN 179 A
Tested acc. to	DIN 18 257
Fixable bearing	■
Steel base in inner and outer plate	■
Concealed through-screw technology	■
Inside with lever	■

■ Yes - No □ Option

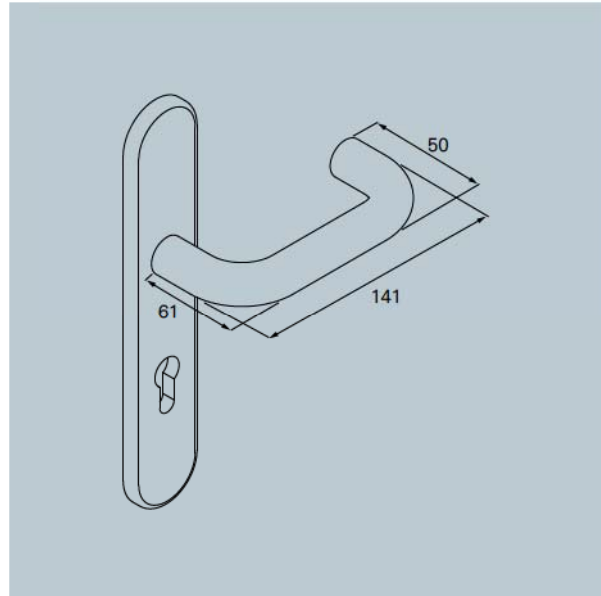

Steel door

Material:



Stainless Steel



Aluminium



Wooden door



PRODUCT FAMILY D-100

Standard handle



D-110



D-120



D-190

Handle on plate



D-110



D-110

Oval rose handle

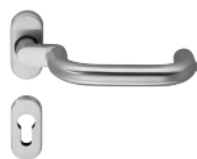

D-115



D-116

Security handle



D-110



D-111



D-116

Window handle



F-110

D-110 Long plate security handle set ES 3



D-110 Long plate security handle set ES 3 with OGI

Fixed in maintenance-free bearing.

Anti-burglary protection class ES 3 / class 4.

Available with knob K-130 and grip plates G-160 and G-180.

Utilization category: class 4

Outside: mounting height 15 mm



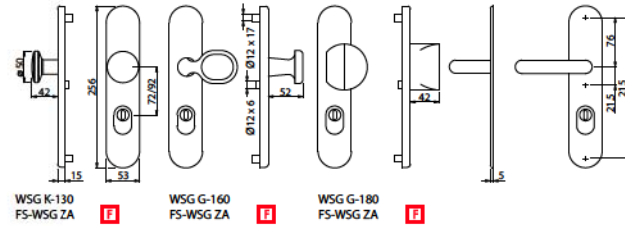

FS-92 on request

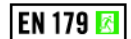
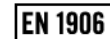
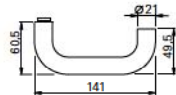

OGI - LONG PLATE SECURITY HANDLE SET





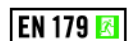
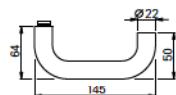

Kit sets ZA

	∅	Distance	∇				
S	21 mm	72 mm	8 mm	713312.46	713342.46	713322.46	713362.46
F	21 mm	72 mm	9 mm	763312.46	763342.46	763322.46	763362.46
FS	21 mm	92 mm	10 mm	743512.46	743542.46	743522.46	743562.46

Finish: Stainless steel satin, further colours on request



Kit sets ZA

	∅	Distance	∇				
S	22 mm	72 mm	8 mm	713312.30	713342.30	713322.30	713362.30
F	22 mm	72 mm	9 mm	763312.30	763342.30	763322.30	763362.30
FS	22 mm	92 mm	10 mm	743512.30	743542.30	743522.30	743562.30

Finish: Aluminium anodized, further colours on request.