

MCR ALPE – ENKELE DRAAIDEUR Ei<sup>2</sup>-30  
 Hoekkozijn (standaard) gelaste scharnieren (standaard)

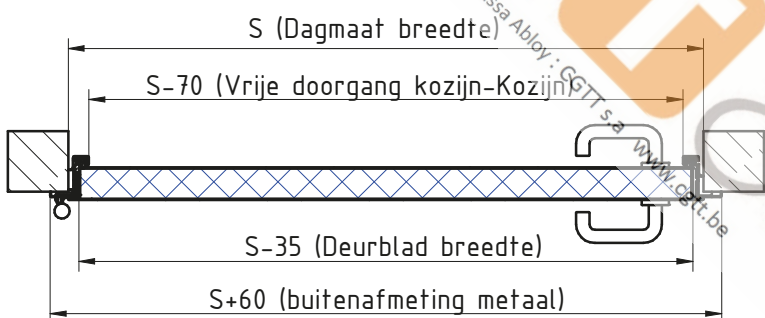

DÉTAIL A

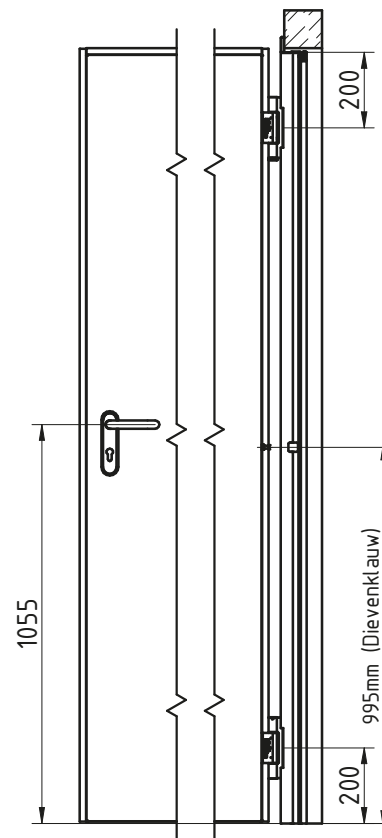
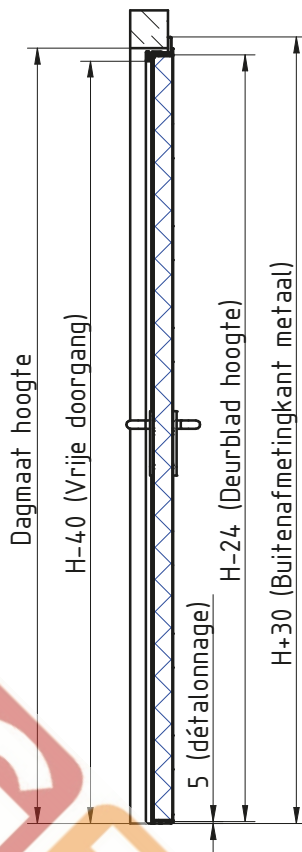
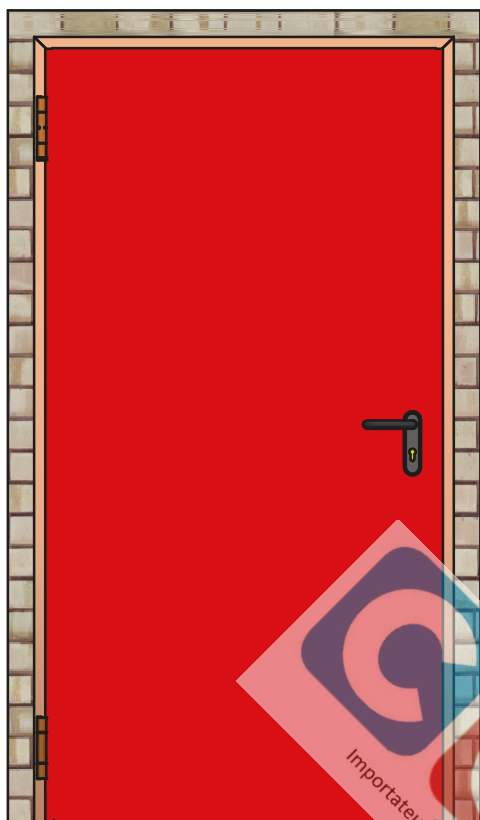
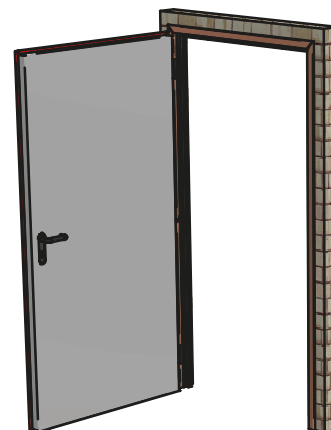
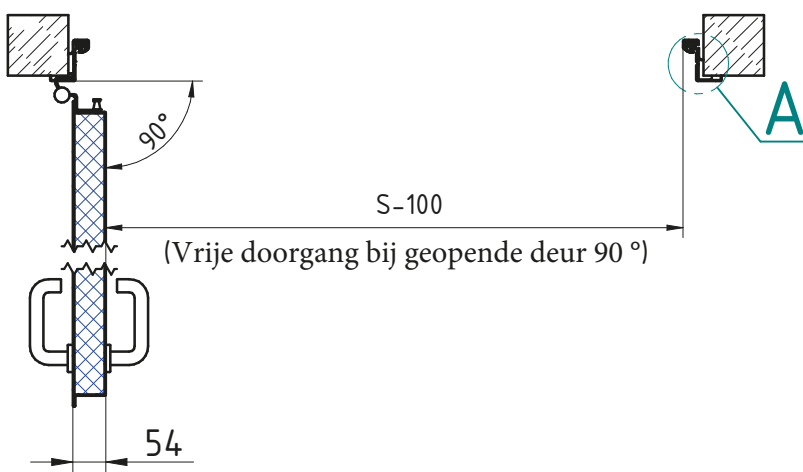
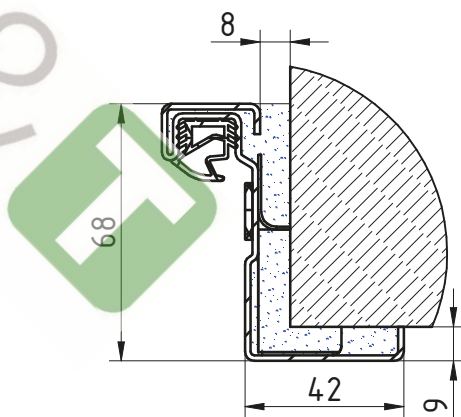

\*Zie fiche over inkerven van beton