

MCR ALPE – ENKELE DRAAIDEUR Ei<sup>2</sup>-60  
 ENVELOPPEKOZIJN gelaste scharnieren (standaard)

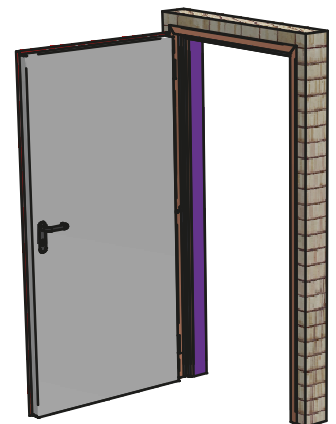
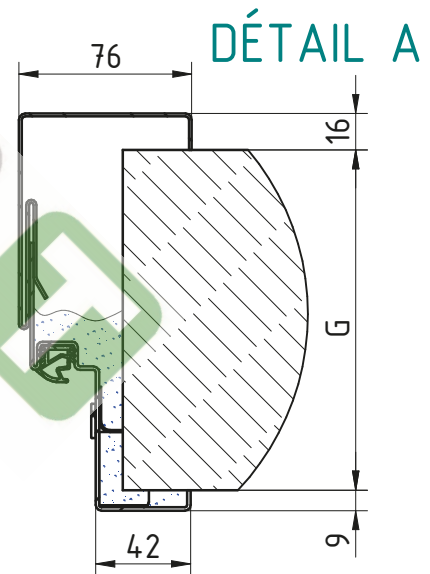
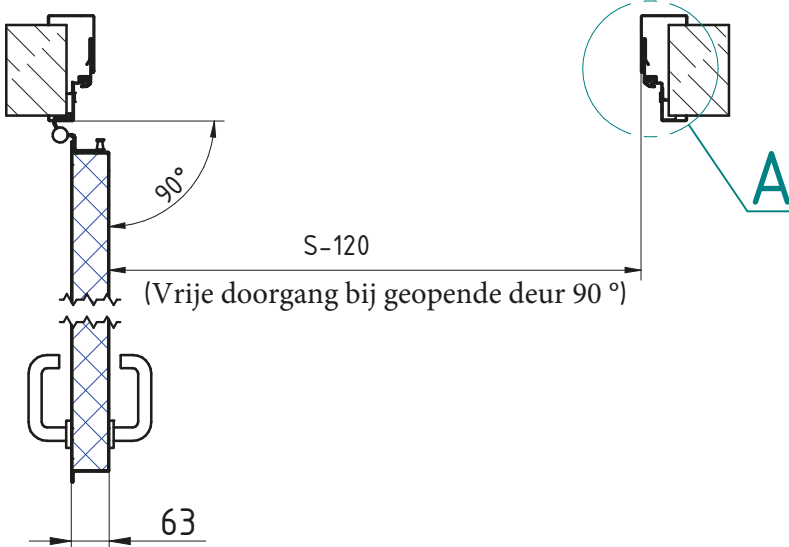
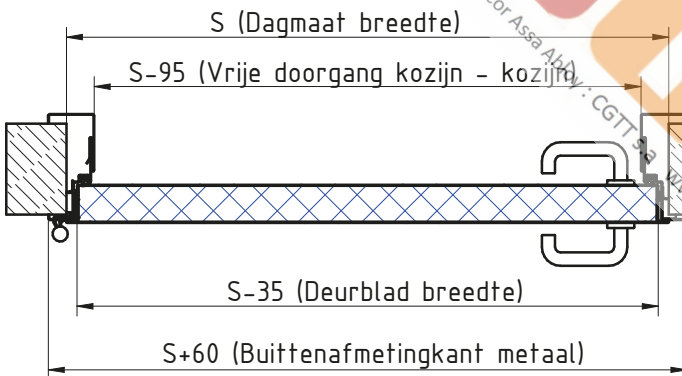
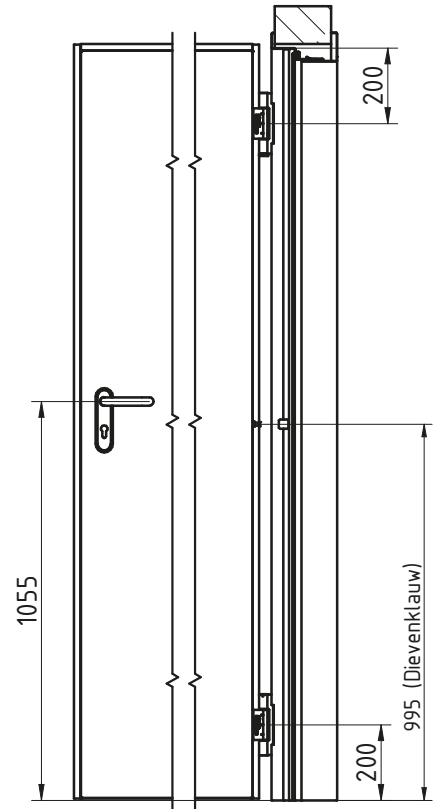
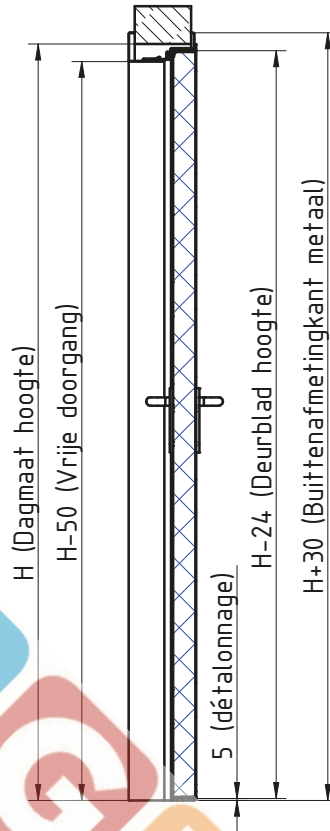
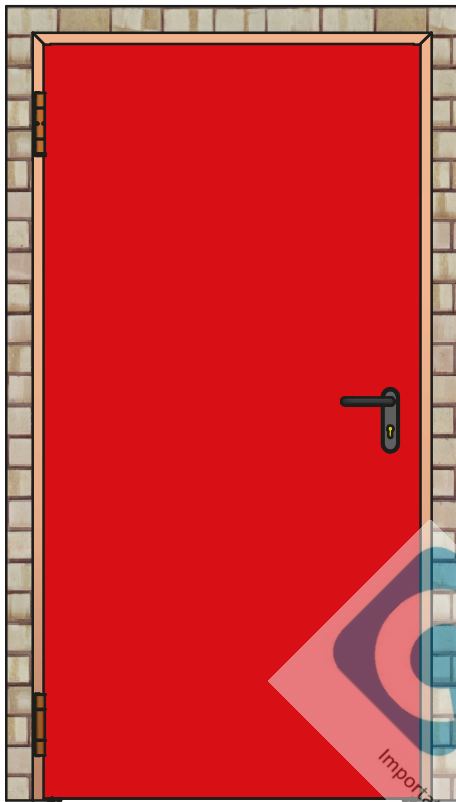

\*\*Zie fiche over inkerven van beton